



Smart solutions.
Strong relationships.

For Employee Exclusive Pricing for CG Fans

Please write to:

✉ arvind.sondagar@cgglobal.com

Or Call Customer Care @ 1800-267-0505



murugappa



Smart solutions.
Strong relationships.



Experience Comfort

Powered by Innovation



murugappa



Relax, recharge, and enjoy
the luxury of smart cooling

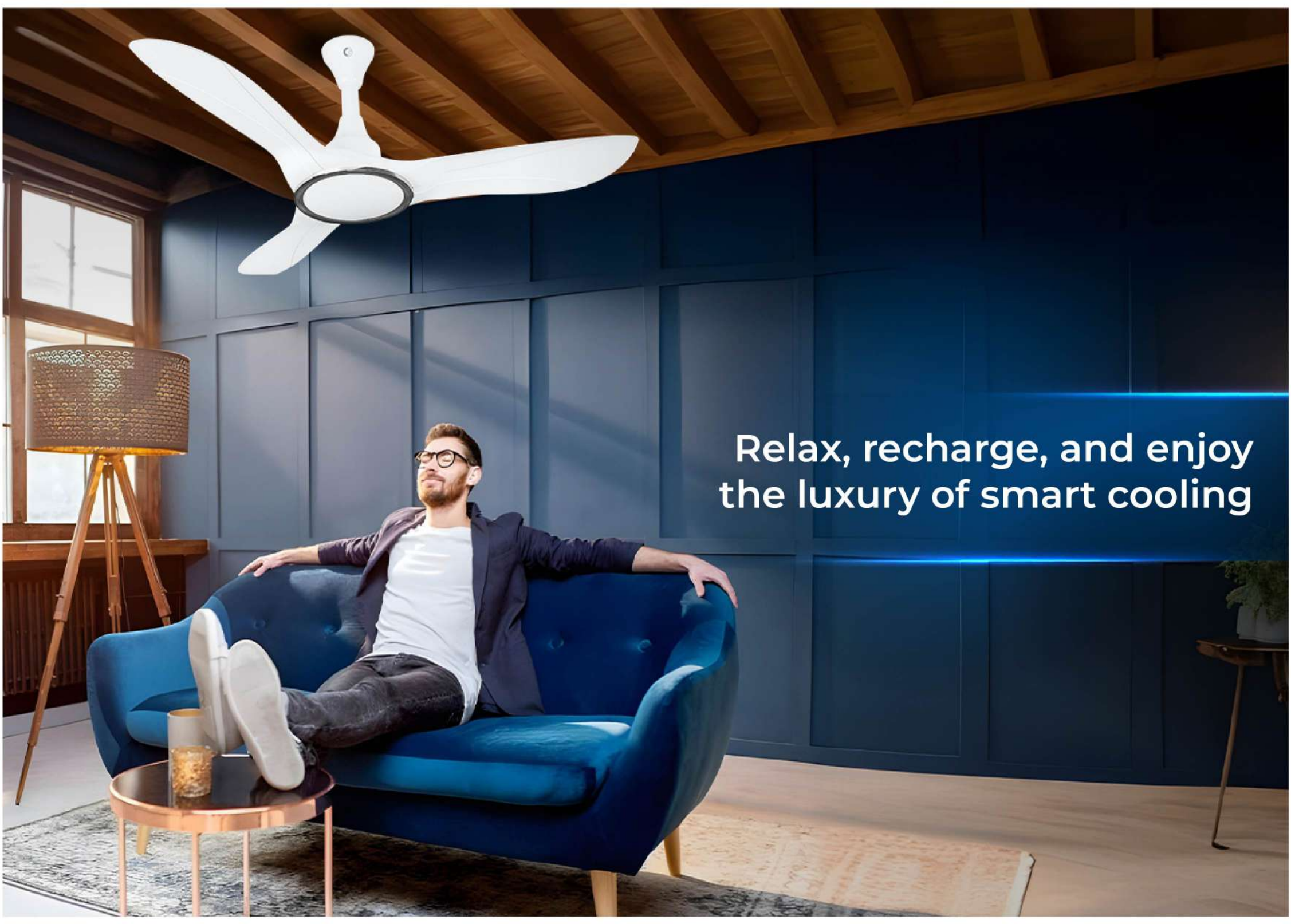



Smart solutions.
Strong relationships.

ABOUT US

CG Power and Industrial Solutions Limited (CG), founded in 1937, is a global leader in electrical energy management, offering innovative, end-to-end solutions for sustainable power use.

With manufacturing facilities across Madhya Pradesh, Maharashtra, and Goa, CG is among the largest manufacturers of electrical equipment for power and industrial sectors, exporting to 130+ countries.

With over 86 years of excellence, CG re-entered the consumer market in 2019 with a range of pumps and exhaust fans, followed by ceiling and multi-purpose fans in 2021. In 2022, we expanded into instant and storage water heaters designed for reliability, backed by decades of trusted expertise and an extensive legacy.

At CG Power and Industrial Solutions Limited (CG), we blend innovation with reliability, making us a trusted choice across Indian homes.



Smart solutions.
Strong relationships.

OUR PURPOSE

Transforming your needs into smart solutions for an enhanced quality of life.

OUR CORPORATE MISSION

Our mission is to lead in the design and delivery of superior electrical solutions, continually advancing in technology and customer satisfaction. With a commitment to quality and sustainability, we aim to build long-term trust, support industrial growth, and enrich lives through our products and services.





FANS | WATER HEATER | PUMP | AIR COOLER



*Soon To Launch: Tower Fan & Air Cooler

INDEX

1 **BLDC Fan** **04**

2 **Induction Fan** **12**

3 **Pedestal Fan** **27**



4 **Table Fan** **35**

5 **Wall Fan** **39**

6 **Exhaust Fan** **47**

STAR RATING CHART



Star Rating	For sweep size <1200 mm i.e., for blade sweep of 900mm and 1050mm following would be the star rating plan.	For sweep size >1200 mm i.e., for blade sweep of 1200mm, 1400mm and 1500mm the star rating plan would be as shown in the table below.
	Service Value	Service Value
 1 Star	≥ 3.1 to <3.6	>4.0 to <4.5 for 1200 mm >4.1 to <4.5 for 1400 mm >4.3 to <4.5 for 1500 mm
 2 Star	≥ 3.6 to <4.1	>4.0 to <5.0
 3 Star	≥ 4.1 to <4.6	>5.0 to <5.
 4 Star	≥ 4.6 to <5.1	>5.5 to <6.0
 5 Star	≥ 5.1	>6.0

The table below shows the minimum performance value that fans need to comply with based on their blade span.

Fan Size Sweep Size MM	Minimum Air Delivery (m ³ /min)	Minimum Service Value (m ³ /min/W)
900	130	3.1
1050	150	3.1
1200	210	4.0
1400	245	4.1
1500	270	4.3

CEILING FAN SELECTION GUIDELINES

Ceiling Fan Selection

How do you choose a fan?



Sweep Size

the sweep size of a fan is simply the total width of its spinning blades.

General Guidelines for selection of ceiling fans

Room Size Sq.ft	Room Type	Fan Sweep Size (Inch)
Upto 100	Puja Room, Balcony, Bathroom	36
100-144	Utility Rooms, Small Bedrooms, Porches	42
144-225	Medium Bedrooms, Kitchens, Dining Rooms	48
225-375	Office Room, Hall, TV Room, Small Garages	56
375-450	Large Office Space, Large Hall	2 fans can be used

Guidelines to install 2 or more fans with a space as specified below





Room Size (Sq.ft)	Center Distance in Feet
Upto 100	36
100-144	42
144-225	48
225-375	56
375-450	2 fans can be used

SAVE SMART







Experience excellence with our BLDC technology, BEE 5-star rating, and unbeatable energy savings.



BLDC FANS SAVE ₹8410 ANNUALLY*

	Conventional Fan	BLDC
 Power Consumption	75W	30W
 Hours of Usage per day	16 hrs	16 hrs
 KWhr Units per day (Power x hours /100)	1.2	0.48
 Electricity bill per day @ ₹ 8/unit	₹ 9.6	₹ 3.8
 Electricity bill per year	₹ 3504	₹ 1402
Save ₹ 2102/- per fan annually		
Annual savings for 4 fans		₹ 8410

Ceiling Fan Downrod Chart

8' - 9'	10'	11'	12'	13'	14'	15' +
						
Use included downrod	12" - 18"	18" - 24"	24" - 36"	36" - 48"	48" - 60"	*72" or More

CG TRANSFORMATION

1878

The beginning

The origins of CG can be traced back to the pioneering work of Colonel REB Crompton, who, in 1878 founded a business at Chelmsford, Essex, England under the name of REB Crompton & Co., to engage in the manufacture and contracting of electrical equipment.

1927

The merger

REB Crompton & Co. merged with F&A Parkinson Limited, thereby establishing Crompton Parkinson Limited (CPL) in England.

1937

Presence in India

CPL established its wholly owned Indian subsidiary 'Crompton Parkinson Works Ltd.', in Mumbai, along with a sales organization, 'Greaves Cotton & Crompton Parkinson Ltd.'

1947

Thapar group company

With the dawn of the independence of India, the company was taken over by the eminent Indian industrialist - Lala Karamchand Thapar, who formed the Thapar Group.

1960

Expansion of portfolio

CG took its initial steps to revolutionize its portfolio, which till then comprised only motors and consumer products. It took a major leap in the electrical engineering segment, through the acquisition of transformer technology from Westinghouse Electric Corporation of USA, for manufacture of 400 kV transformers and aluminum wound transformers. This was followed by further expansion in the switchgear, vacuum interrupter and allied businesses.

1996

Established B2B and consumer segments

Thapar group created Crompton Greaves Limited to meet the electrical demand of B2B and consumer segments.

2004

The leading electrical giant

The Company had emerged as one of the leading companies in the electrical engineering domain of India, in its three business areas of Power Systems, Industrial Systems and Consumer Products; and a serious contender in the global arena.

2005

International footprint

CG established its international manufacturing footprint in the year 2005 by acquisition of the Belgium based Pauwels Group, which gave CG additional manufacturing facilities for Power and Distribution transformers at Belgium, Ireland, USA and Indonesia. This was followed with a series of successful acquisitions - Ganz, Hungary in 2006; Microsol, Ireland in 2007; Sonomatra, France; MSE, USA in 2008 and PTS, UK in 2010.

2015

The demerger

The heavy engineering business of the company was demerged to form a separate entity CG Power and Industrial Solutions Limited, as we know it today.

Demerger of Consumer BU, India

2020

The acquisition

Tube Investments of India Ltd. (TII), a multi-crore Murugappa Group company, acquired controlling stake in CG Power and Industrial Solutions Ltd.

Re-entry in Fan BU, India



Smart solutions.
Strong relationships.

CG Premium BLDC Ceiling Fan Series

Experience the quiet power of our
BLDC Ceiling Fans

Enjoy optimal airflow, reduced energy bills, and
a serene environment powered by a quiet yet
efficient motor.



CG Caliver



Superior
Air Delivery



Silent
Motor



ABS
Blades



High Air
Thrust



Constant Speed
100V - 270V



Rust
Proof

Advance Remote RF

Sweep	Power Input	Air Delivery	Speed RPM	 5 Star
1200mm	40W	250 CMM	265	

Colours:



White



Wooden Copper



CG Eco 28



Advance Remote **RF**



Superior Air Delivery



Longer & Wider Blades



High Air Thrust



Constant Speed
100V - 270V

Sweep	Power Input	Air Delivery	Speed RPM	 5 Star
1200mm	30W	215 CMM	350	

Colours:



Teak Wood



Rosewood



Matt White



Smoke Brown



CG Elegance



Advance Remote **RF**



Superior Air Delivery



Constant Speed
100V - 270V



Longer & Wider
Blades



Timer Mode



Reverse Mode



Comfort in a Click with
Light & Beep

Sweep	Power Input	Air Delivery	Speed RPM	 5 Star
1200mm	35W	220 CMM	350	

Colours:



Graphite Grey



Pearl White



Terra Brown



CG ImmenseAir



Advance Remote **RF**



Superior Air Delivery



Timer Mode



Reverse Mode



Longer & Wider Blade



High Air Thrust



Constant Speed
100V - 270V

Sweep	Power Input	Air Delivery	Speed RPM	
1200mm	35W	220 CMM	350	

Colours:



Pastel Blue



Pearl White



Silk Grey







Smoke Wood



CG Ultimo Prime



Advance Remote RF

-  Durable Motor by Leaders
-  High Speed
-  Aluminium Body & Blades
-  Double Ball Bearing
-  Metallic Finish
-  High Air Thrust

Sweep	Power Input	Air Delivery	Speed RPM	
1200mm	33W	215 CMM	375	

Colours:

-  Metalic Grey
-  Bakers Brown Matt
-  Teal
-  Platinum White Glossy

- Powered by 
-  60% Energy Saving
- 
- 

CG VectAir Plus



Over & Under
Voltage Protection



Run 3X
on Inverter



Energy
Efficient



Aluminium
Body & Blades

Sweep

Power
Input

Air
Delivery

Speed
RPM

1200mm

30W

210 CMM

350



Colours:



Brown



Opal White



Ivory





Smart solutions.
Strong relationships.

CG Legacy 5 Star



Advance Remote RF



Over & Under
Voltage Protection



Aluminium
Body & Blades



Energy
Efficient



Superior
Air Delivery

Sweep	Power Input	Air Delivery	Speed RPM	5 Star
1200mm	33W	215 CMM	375	

Colours:



Opal White



Matt Brown



Ivory





Smart solutions.
Strong relationships.

CG Royale Induction Ceiling Fan Series

**Designed With Elegance, Made
For Excellence**

Featuring a reliable induction motor, exotic trim design, and durable finish, it provides powerful airflow and keeps you cool even on the hottest days.



CG Cruiser



Exotic Trim Design



Superior Air Delivery



Double Ball Bearing



Premium Colors



High Air Thrust



Aluminium Body & Blades

Sweep	Power Input	Air Delivery	Speed RPM	BEE Rating
1200mm	52W	220 CMM	360	

Colours:



Swede Poly Matt



Aqua Sapphire Matt



White Metallic Glossy



Teal Matt



Teal Glossy



Burgandy Glossy





Smart solutions.
Strong relationships.

CG Ferna



Exotic Trim Design



Superior Air Delivery



Double Ball Bearing



High Air Thrust



Aluminium Body & Blades

Sweep	Power Input	Air Delivery	Speed RPM	BEE Rating
1200mm	52W	220 CMM	360	

Colours:



Warm Grey



Black White



Black Gold



Swede Poly



CG Ultimo



Superior
Air Delivery



Durable Motor
By Leaders



High Speed



High Air
Thrust



Double Ball
Bearing



Wider
Blade

Sweep	Power Input	Air Delivery	Speed RPM	
1200mm	52W	220 CMM	400	

Colours:



Platinum White



Smoke Brown



CG HansAir



-  **Durable Motor By Leaders**
-  **High Speed**
-  **Anti Rust**
-  **High Air Thrust**
-  **Double Ball Bearing**
-  **Metallic Colors**

Sweep	Power Input	Air Delivery	Speed RPM	BEE Rating
1200mm	52W	214 CMM	380	

Colours:



Choco Brown Metallic White Silver Metallic Irish Coffee Metallic Coral Gold Metallic





CG Ferro Plus

-  **Durable Motor By Leaders**
-  **Double Ball Bearing**
-  **Superior Air Delivery**
-  **High Air Thrust**
-  **Long & Wider Blade**

Sweep	Power Input	Air Delivery	Speed RPM	Energy Star
1200mm	56W	225 CMM	360	1 Star

Colours:



White Metallic Brown Burgundy Matt Silver Matt



CG Ferro 425



-  **Durable Motor By Leaders**
-  **Double Ball Bearing**
-  **Superior Air Delivery**
-  **High Air Thrust**
-  **Long & Wider Blade**

Sweep	Power Input	Air Delivery	Speed RPM	
1200mm	50W	215 CMM	425	

Colours:



Matt Brown



Opal White



Ivory





CG RiaAir



- Durable Motor By Leaders
- Double Ball Bearing
- Superior Air Delivery
- High Speed
- High Air Thrust
- Long & Wider Blade

Sweep	Power Input	Air Delivery	Speed RPM	Star Rating
1200mm	54W	230 CMM	380	1 Star

Colours:



Pearl White



Irish Coffee



Graphite Grey



CG TulipAir Deco



Durable Motor
By Leaders



Double Ball
Bearing



High Speed



Exotic Trim
Design



Superior
Air Delivery

Sweep

Power
Input

Air
Delivery

Speed
RPM

1200mm

52W

210 CMM

400



Colours:



Olive



White



Matt Brown



Matt Grey



Lusture Brown



Ivory



Blue



Grey



CG TulipAir



High Speed





Double Ball Bearing



Superior Air Delivery



Premium Colors

Sweep	Power Input	Air Delivery	Speed RPM	BEE Rating
600mm	64W	105 CMM	850	
900mm	38W	130 CMM	450	
1200mm	52W	210 CMM	400	
1400mm	60W	250 CMM	300	

Colours:



Olive Bronze



White



Smoke Brown



Matt Brown



Metalic Grey



Ivory



Lusture Brown



Blue



CG SahajAir



Durable Motor
By Leaders



High
Speed



Double Ball
Bearing

Sweep	Power Input	Air Delivery	Speed RPM	
1200mm	52W	215 CMM	390	



Colours:



Opal White



Lustre Brown



Ivory



CG Hyperair Neo



Premium Colors



Double Ball Bearing



High Speed

Sweep	Power Input	Air Delivery	Speed RPM	
1200mm	52W	210 CMM	380	



Colours:



Matt Brown



White



Lustre Brown



Ivory



Blue



Smoke Brown

CG IndiAir



Durable Motor
By Leaders



High
Speed



Double Ball
Bearing

Sweep	Power Input	Air Delivery	Speed RPM	
900mm	49W	180 CMM	600	



Colours:



Opal White



Lustre Brown

CG HS Legacy



Durable Motor
By Leaders



High Speed



Long & Wider
Blade

Sweep	Power Input	Air Delivery	Speed RPM	BEE Rating
600mm	70W	110 CMM	850	
900mm	44W	140 CMM	450	
1200mm	52W	220 CMM	390	

Colours:



Matt Brown



Ivory



Opal White





Smart solutions.
Strong relationships.

CG TPW Fans

Versatile Cooling, Anywhere You Need It

CG's Table, Pedestal, and Wall Fans offer powerful airflow, energy efficiency, and sleek designs. Whether it's consistent cooling, adjustable comfort for larger spaces, or saving floor space, these fans adapt to every need.



Smart solutions.
Strong relationships.

CG Pedestal Fans

Durable, Convenient, Accessible

Experience cooling that provides comfort at every turn!
CG pedestal fans bring unmatched flexibility and powerful
airflow to elevate your everyday comfort.



CG Vheg



High Speed
Motor



Wide Angle
Oscillation



Longer
Life



Powerful
Airflow



Rustproof
Wide Blade

Sweep	Power Input	Air Delivery	Speed RPM
400mm	100W	80 CMM	2250

Colours:



Cloud White



Black



Red & Black





Smart solutions.
Strong relationships.

CG Aircon



Rustproof
Wide Blade



Wide Angle
Oscillation



Longer
Life

Sweep

Power
Input

Air
Delivery

Speed
RPM

400mm

58W

65 CMM

1350



Colours:



Cloud White



Black



Black Red



Smart solutions.
Strong relationships.

CG FlyAir



Rustproof
Wide Blade



Wide Angle
Oscillation



Longer
Life

Sweep

400mm

Power Input

58W

Air Delivery

65 CMM

Speed RPM

1350



Colours:



Cloud White



Smart solutions.
Strong relationships.

CG Champ Air



Double Ball Bearing



Wide Angle Oscillation



Sturdy Metal Body



Powerful Airflow



Rustproof Aluminium blade

Sweep	Power Input	Air Delivery	Speed RPM
450mm	100W	135 CMM	1350

Colours:



Black





Smart solutions.
Strong relationships.

CG ChampAir Neo



Powerful
Airflow



Wide Angle
Oscillation



Longer
Life



Efficient
Design



Rustproof
Aluminium blade



Sturdy Metal
Body

Sweep	Power Input	Air Delivery	Speed RPM
450mm	100W	105 CMM	1350

Colours:



Black



CG WarriAir



Sturdy Metal Body



Wider Metal Blade



Powerful Airflow



Longer Life



Efficient Design

Sweep	Power Input	Air Delivery	Speed RPM
500mm	130W	6900 CMH	1375

Colours:



Grey





Smart solutions.
Strong relationships.

CG Table Fans

Compact, Practical, Portable

Need cooling on demand? Our table fans bring portable comfort wherever you go. Compact, powerful, and stylish—these fans keep you cool with ease.



CG Vheg



High Speed Motor



Wide Angle Oscillation



Longer Life



Powerful Airflow



Rustproof Wide Blade

Sweep	Power Input	Air Delivery	Speed RPM
400mm	100W	80 CMM	2250

Colours:



Cloud White



Black



Red & Black



CG FlyAir



Rustproof
Wide Blade



Wide Angle
Oscillation



Longer
Life

Sweep	Power Input	Air Delivery	Speed RPM
400mm	58W	65 CMM	1350



Colours:



Cloud White

CG Aircon



Longer
Life



Rustproof
Wide Blade



Wide Angle
Oscillation

Sweep	Power Input	Air Delivery	Speed RPM
400mm	58W	65 CMM	1350



Colours:



Cloud White



Black



Black Red



Smart solutions.
Strong relationships.



CG Wall Fans

Lightweight, Powerful, Durable

Save space while staying cool. CG wall fans provide targeted airflow in areas where floor or table space is limited. Reliable, powerful, and out of the way.



CG Vheg



High Speed
Motor



Wide Angle
Oscillation



Longer
Life



Powerful
Airflow



Rustproof
Wide Blade

Sweep	Power Input	Air Delivery	Speed RPM
300mm	80W	60 CMM	2250
400mm	100W	80 CMM	2250

Colours:



Cloud White



Black



Red & Black



CG FlyAir



Rustproof
Wide Blade



Wide Angle
Oscillation



Longer
Life

Sweep	Power Input	Air Delivery	Speed RPM
400mm	58W	65 CMM	1350



Colours:



Cloud White

CG Aircon



Rustproof
Wide Blade



Longer
Life



Wide Angle
Oscillation

Sweep	Power Input	Air Delivery	Speed RPM
400mm	58W	65 CMM	1350



Colours:



Cloud White



Black



Black Red

CG Champ Air



Double Ball Bearing



Wide Angle Oscillation



Sturdy Metal Body



Powerful Airflow



Rustproof Aluminium blade

Sweep	Power Input	Air Delivery	Speed RPM
450mm	100W	135 CMM	1350

Colours:



Black



CG ChampAir Neo



Powerful
Airflow



Wide Angle
Oscillation



Longer
Life



Efficient
Design



Rustproof
Aluminium blade

Sweep	Power Input	Air Delivery	Speed RPM
450mm	100W	105 CMM	1350

Colours:



Black



CG PowAir

All Purpose Fan



Rustproof
Body



Wide Angle
Oscillation



Longer
Life

Sweep

Power
Input

Air
Delivery

Speed
RPM

230mm

50W

28 CMM

2500



Colours:



White



CG Exhaust Fans

Maintenance Made Easy

Breathe easy with CG exhaust fans. Perfect for kitchens, bathrooms, and offices, these fans keep your space fresh and clean by removing odors and moisture effectively.

CG PoshAir HS



- 
**Powerful
Air Suction**
- 
**Durable
Motor**
- 
**Longer
Life**
- 
**Louvered
Shutter**

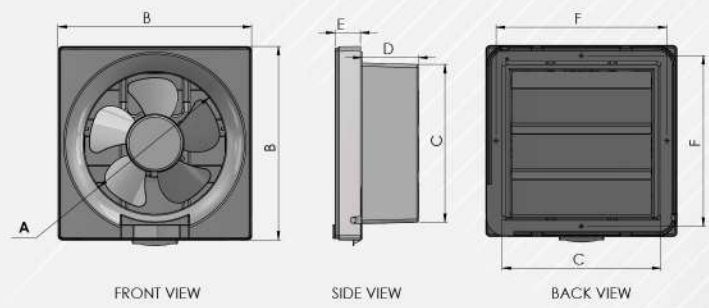

Sweep	A	B	C	D	E	F
150mm	168	243	193.5	85	35	206
200mm	214	293	244	85	40	262
250mm	264.5	340	294	90	40	312

*All dimensions are in mm

Sweep	Power Input	Air Delivery	Speed RPM
150mm	40W	500 CMH	2500
200mm	65W	750 CMH	2100
250mm	67W	1200 CMH	2000

Colours:

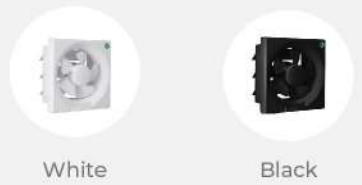

CG PoshAir



Light & Rustproof
Body



Aerodynamic
Blade



Durable
Motor



Longer
Life



Louvered
Shutter

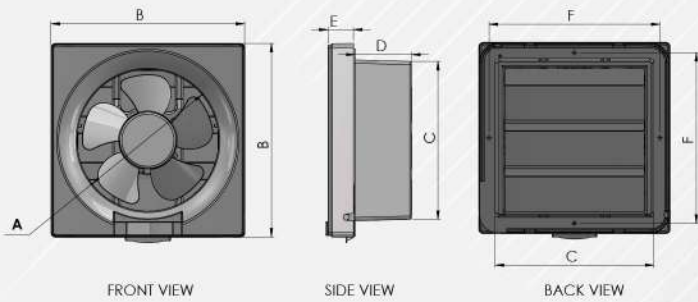

Sweep	A	B	C	D	E	F
150mm	168	243	193.5	85	35	206
200mm	214	293	244	85	40	262
250mm	264.5	340	294	90	40	312
300mm	295	392	335	85	45	353

*All dimensions are in mm

Sweep	Power Input	Air Delivery	Speed RPM
150mm	32W	280 CMH	1350
200mm	36W	500 CMH	1300
250mm	38W	750 CMH	1250
300mm	45W	1200 CMH	1150

Colours:



White



Black



CG FloAir



Fins For Safety



Durable Motor



Longer Life

Sweep	Power Input	Air Delivery	Speed RPM
100mm	18W	90 CMH	2500
150mm	22W	250 CMH	1800

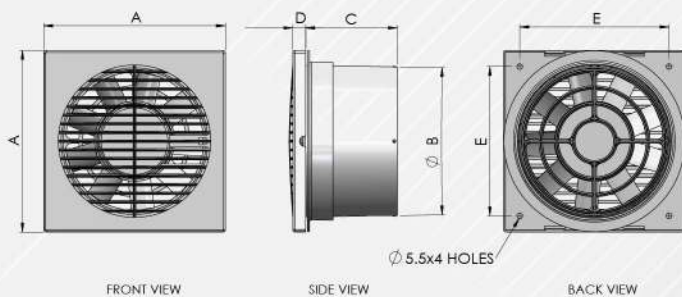

Sweep	A	B	C	D	E
100mm	150	110	90	10	115
150mm	178	148	95	10	146

*All dimensions are in mm

Colours:



White



Black



CG MaxAir Plus



Powerful
Air Suction



Fins For
Safety



Durable
Motor



Longer
Life

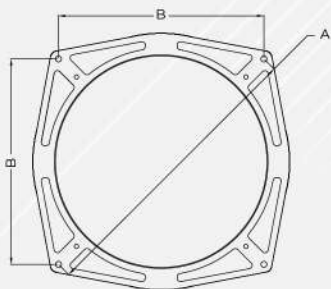

Sweep	A	B
225mm	321	226
300mm	438	310

*All dimensions are in mm

Colours:



Smoke Grey

Sweep	Power Input	Air Delivery	Speed RPM
225mm	50W	700 CMH	1425
300mm	75W	1750 CMH	1400





Smart solutions.
Strong relationships.

CG MaxAir



Powerful
Air Suction



Fins For
Safety



Durable
Motor



Longer
Life

Sweep	Power Input	Air Delivery	Speed RPM
150mm	50W	600 CMH	2700
225mm	42W	600 CMH	1375
300mm	55W	1200 CMH	1375

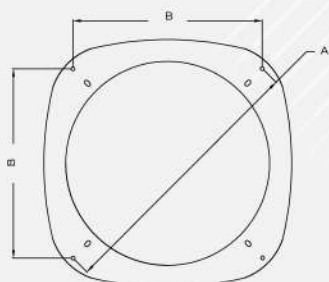

Sweep	A	B
150mm	236	167
225mm	325	230
250mm	426	301

*All dimensions are in mm

Colours:



Smoke Grey





Smart solutions.
Strong relationships.

CG Powerair



Powerful
Air Suction



Durable
Motor

Sweep	Power Input	Air Delivery	Speed RPM
300mm	90W	1710 CMH	1350
380mm	160W	3000 CMH	1350
450mm	250W	5500 CMH	1350
600mm	550W	8700 CMH	900

Colours:



Grey



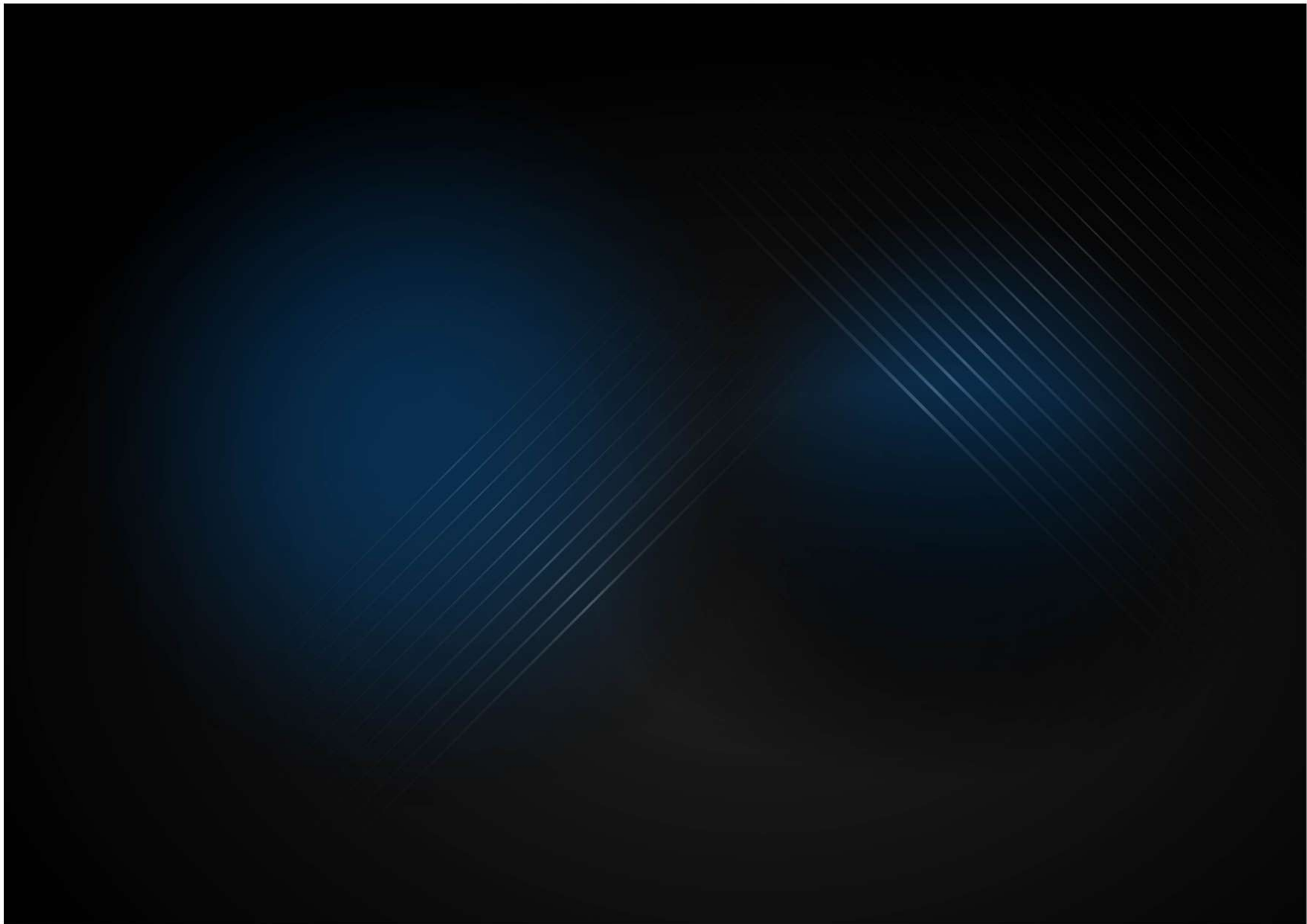

CG Power and Industrial Solutions Limited

Customer Service

☎ 1800-267-0505

☎ 91526 70505

✉ cgcp.care@cgglobal.com

🌐 www.cgglobal.com



